

4 - WIRE TOUCHSCREEN SPECIFICATION

VER. 11.10.0

MODEL: HT150A-NENBS52-R

DATE: October 1, 2011

Approved

Signature

Printed Name

Company

/_____
Date

ATTENTION: REGARDING STYLUS APPLICATIONS

NOTE: If your application calls for the use of a stylus or similar input device, you must use double layer film or **WARRANTY IS VOID**. If uncertain about your method of input, please contact us.

Double layer film is available for ALL HantouchUSA 4-wire analog resistive touch screens.

ATTENTION: REGARDING HIGH-RISK APPLICATIONS

The Products have not been designed, manufactured, tested or qualified for use in any high-risk application (a "High-Risk Application"), including, but not limited to, the following: life support or life sustaining, "medical device" as defined by applicable law, nuclear, vehicle control (including airplane, automotive, train and other vehicle) or any other application in which failure of the Product, or the product into which it is incorporated, could foreseeably result in personal injury, death, or significant property damage.

To contact us, please call us at 425.774.8151 or
send email to sales@hantouchUSA.com
Visit us on the web at www.hantouchUSA.com

INSPECTION AND WARRANTY

Inspection

Within 30 days after delivery customer will inspect the products and give written notice of rejection to Hantouch USA detailing the manner in which any products do not conform to specifications. Upon receiving authorization and shipping instructions from Hantouch USA, customer may return rejected products. If the customer retains the products after their delivery without giving Hantouch USA such notice within the designated period, customer will be deemed to have irrevocably accepted the products. Customer's inspection and acceptance tests shall not exceed the inspection and test procedures customary in the industry for the products and shall be at customer's expense. Hantouch USA may charge to the customer any costs resulting from the testing, handling, and disposition of any products returned by the customer which are not found by Hantouch USA to be non-conforming.

Warranty

Hantouch USA warrants to customer that the products will be free from defects in material and workmanship under normal use and service for a period of one year from date of manufacture. Customer's exclusive remedy for breach of this warranty is that Hantouch USA will either (i) repair or replace, at its option, any product which fails during the warranty period because of such defect (if customer promptly reported the failure to Hantouch USA in writing) or, (ii) if Hantouch USA is unable to repair or replace, Hantouch USA will refund the purchase price of the product upon its return to Hantouch USA.

This warranty does not apply to any product which has been subjected to misuse, abnormal service or handling, or which has been serviced, repaired or modified by anyone other than Hantouch USA. The warranties set forth herein are in lieu of, and exclusive of, all other warranties, express or implied.

ALL EXPRESS AND IMPLIED WARRANTIES OF MERCHANTABILITY, FITNESS FOR USE AND FITNESS FOR A PARTICULAR PURPOSE ARE SPECIFICALLY EXCLUDED.

Product that has been mounted and removed is not returnable for cosmetic defects; scratches, chips or cracks.

Hantouch USA reserves the right to make changes in the specifications, Characteristics, data, materials, structures and other contents described herein at any time without notice in order to improve design or reliability. Contact Hantouch USA in order to obtain the latest specification sheets before using any Hantouch USA device. Manufacturing locations are also subject to change.

CONTENTS

Warranty

Page	Topic
2	Inspection and warranty

INSPECTION

Page	Topic
4	Scope
	Warranty
	Shape
	Feature
	Rating
	Electrical Characteristics
5	Mechanical Characteristics
	Optical Characteristics
	Reliability
6	Durability
7	Cosmetic Inspection Criteria
8	Inspection
9	Handling Remarks

DEVICE DRAWING

10	Mechanical Drawing
----	--------------------

1. Scope

This specification is applied to HantouchUSA Product number as listed on page 1.

2. Warranty

For warranty information see page 2 of 10

3. Shape

Shape, structure and dimension are defined by the drawing on page 10.

4. Features

Type	4-Wire Analog Resistive Touch Panel	
Input Mode	Finger	
Structure	ITO Film	175/188 μ m
	ITO Glass	0.7/1.1/1.8T
Connector	FPC	

5. Rating

5.1 Maximum Voltage & Current

Less than DC 7 volts, 1ma

- At the contact point of ITO Film (top layer) and ITO Glass(bottom layer)

5.2 Operating Temperature Range

- 20 °C to 60 °C (Humidity : 20% RH to 90% RH)

5.3 Storage Temperature Range

-30 °C to 70 °C (Humidity : 20% RH to 90% RH)

6. Electrical Characteristics

6.1 Resistance between Lead

Direction "Y" : 100 ~ 1200 Ω

Direction "X" : 100 ~ 1200 Ω

6.2 Linearity

X axis : \pm 1.5%

Y axis : \pm 1.5%

6.3 Insulation Resistance

20 M Ω or more at DC 25 V

6.4 Chattering Time

10 msec or less at 100k Ω Pull-up

7. Mechanical Characteristics

7.1 Input Method

- Finger only

7.2 Actuation Force

- Finger only: 80 g or less (R 8.0 HS40° Silicon Rubber)

7.3 Surface Hardness

- 3H or more (according to JIS-K5400)

8. Optical Characteristics

8.1 Transmittance

80 % or more

Measurement by SpectroPhotometer MINOLTA CM-3500d

9. Reliability

9.1 High Temperature Test

Touch Panel is put into a vessel at 70 °C for 240 hours.
Then it is left at room temperature for 24 hours or more.
The measurement must satisfy the following :

- Resistance between terminals : According to Section 6.1
- Linearity : According to Section 6.2
- Insulation Resistance : According to Section 6.3

9.2 Low Temperature Test

Touch Panel is put into a vessel at -30°C for 240 hours.
Then it is left at room temperature for 24 hours or more.
The measurement must satisfy the following :

- Resistance between terminals : According to Section 6.1
- Linearity : According to Section 6.2
- Insulation Resistance : According to Section 6.3

9.3 Temperature & Humidity Test

Touch Panel is put into a vessel 60°C and 90%RH
For 240 hours. Then it is left at room temperature for 24 hours or more.
The measurement must satisfy the following :

- ▶ Resistance between terminals : According to Section 6.1
- ▶ Linearity : According to Section 6.2
- ▶ Insulation Resistance : According to Section 6.3

9.4 Thermal Shock Test

Touch Panel is put into a vessel at -30°C for 30 minutes
And then 70°C for 30 minutes. This process is repeated by 10 cycles.
Then it is left at room temperature for 24 hours or more.
The measurement must satisfy the following :

- ▶ Resistance between terminals : According to Section 6.1
- ▶ Linearity : According to Section 6.2
- ▶ Insulation Resistance : According to Section 6.3

9.5 Keep Out Area

Do not put buttons or other touch features within 3mm of the internal spacer.
Design your system in such a way that a touch right next to the bezel is
3mm or more from said internal spacer.

10. Mounted Product

10.1 Removed Product

Product that has been mounted and removed is not returnable for
Cosmetic defects: scratches, chips and cracks.

10.2 Bezel/Top Gasket Caution:

The top film must be allowed to move (expand and contract).
Do not bond the top film directly to the bezel. Do not use a gasket that does not allow the
top film to move (expand and contract). Do not use a clamping force so great that the top
film can not move (expand and contract).

10.3 Cleaning:

Be sure the cloth is only lightly dampened not wet. Never apply cleaner directly to the
touch panel surface. Do not use water based cleaning products.
Do not allow liquids to come into contact with the edges of the touch panel

11. Cosmetic Inspection Criteria

The following are applied to viewing area.

Any nonvisible defect shall be ignored unless it affects electrical performance.

The Inspection shall be performed by using two 14W fluorescent lamps.

The panel shall be placed 30cm away from eyes as shown below.

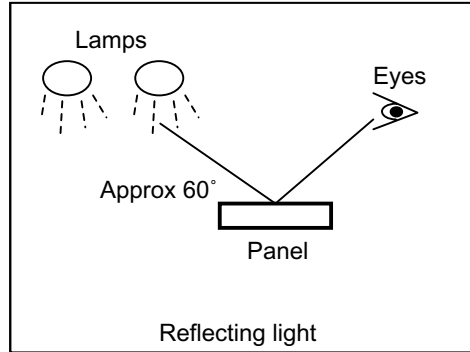
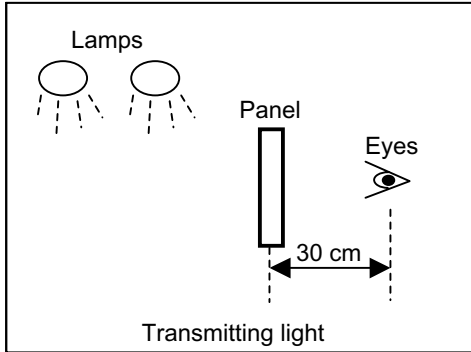

11.1 Scratch

W less than 0.04mm	In case of $L \leq 10\text{mm}$, it is disregarded
$0.04\text{mm} < W < 0.06\text{mm}$	In case of $L \leq 10\text{mm}$, it is disregarded in case the object is in a distance of $L < 15\text{mm}$ from any other objects or scratches. (2 or less) In case of $L > 10\text{mm}$, it is regarded as defects.
$W > 0.06\text{mm}$	In case $L > 10\text{mm}$, it is regarded as a defect.

11.2 Granular Object

$D \leq 0.25\text{mm}$	Disregarded
$0.25\text{mm} < D \leq 0.40\text{mm}$	It is regarded as a defect in the case the object is in a distance of $< 15\text{mm}$ from any other objects or scratches. (2 or less)
$0.40\text{mm} < D$	It is regarded as a defect.

$D = (X+Y)/2$

11.3 Linear Object

$W \leq 0.04\text{mm}$	In case of $L \leq 10\text{mm}$, it is disregarded
$0.04\text{mm} < W < 0.06\text{mm}$	In case of $L \leq 10\text{mm}$, it is disregarded in case the object is in a distance of $L < 15\text{mm}$ from any other objects or scratches. (2 or less) In case of $L > 10\text{mm}$, it is regarded as defects.
$W > 0.06\text{mm}$	In case L is greater than 10mm, it is regarded as a defect.

11.4 Glass breakage

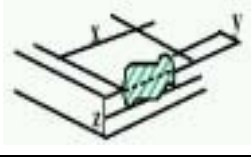
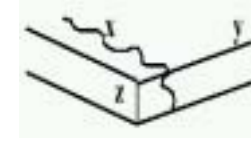
	CRITERION & DECISION																	
Corner breakage		$X \leq 3.0\text{mm}$ and $Y \leq 3.0\text{mm}$ and $Z \leq t$ It is ignored																
Side breakage		<table border="1"> <thead> <tr> <th>X(mm)</th> <th>Y(mm)</th> <th>Z(mm)</th> <th>Decesion</th> </tr> </thead> <tbody> <tr> <td>≤ 3.0</td> <td>≤ 3.0</td> <td>$\leq t$</td> <td rowspan="3">Ignored</td> </tr> <tr> <td>≤ 5.0</td> <td>≤ 1.0</td> <td>$\leq t$</td> </tr> <tr> <td>≤ 5.0</td> <td>≤ 3.0</td> <td>$\leq 2/3t$</td> </tr> </tbody> </table>	X(mm)	Y(mm)	Z(mm)	Decesion	≤ 3.0	≤ 3.0	$\leq t$	Ignored	≤ 5.0	≤ 1.0	$\leq t$	≤ 5.0	≤ 3.0	$\leq 2/3t$		
X(mm)	Y(mm)	Z(mm)	Decesion															
≤ 3.0	≤ 3.0	$\leq t$	Ignored															
≤ 5.0	≤ 1.0	$\leq t$																
≤ 5.0	≤ 3.0	$\leq 2/3t$																
Progressive		It is regarded as defective.																

※ t : Glass Thickness

11.5 Puffiness

Check Puffiness with 0.5mm gauge

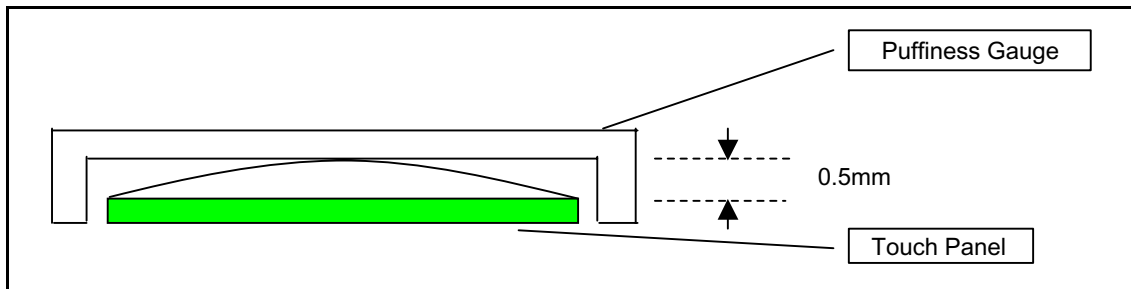

11.6 Newton's Ring

Subject to limited sample agreed between buyer and manufacturer.

12. Inspection

12.1 Resistance between Lead

Criterion : According to Section 6.1

All the Touch Panels are inspected in the first production lot.
Sampling inspection from second lot.

12.2 Linearity

Criterion : According to Section 6.2

All the Test Touch Panels are inspected in the first production lot.
Sampling inspection from second lot.

12.3 Insulation Resistance

Criterion : According to Section 6.3

All the Touch Panels are inspected in the first production lot.
Sampling inspection from second lot.

12.4 Appearance

Criterion : According to Section 11

All the Touch Panels are inspected.

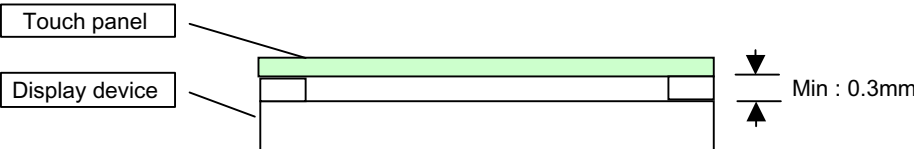
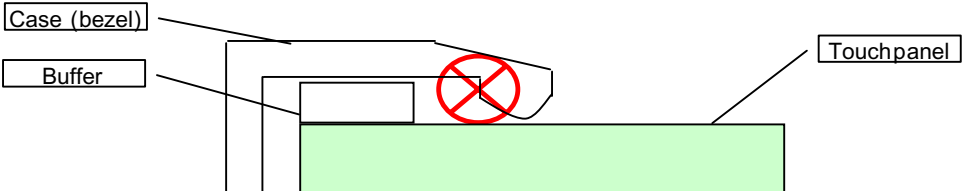
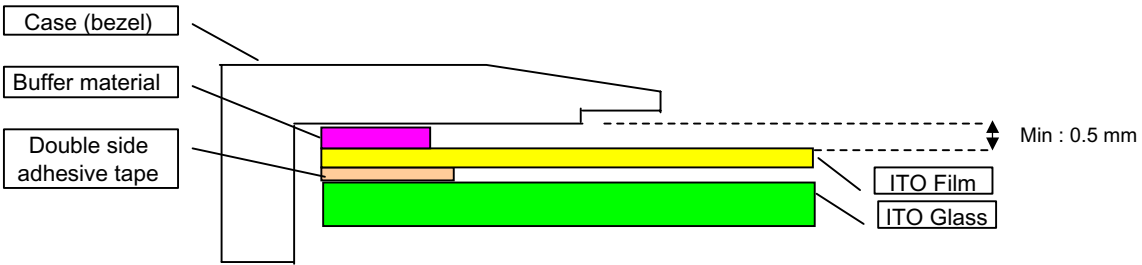
13. Handling Remark	
Subject	Description
Storage	<ol style="list-style-type: none"> 1. Always store touch panel at Storage Environment. (Ref. 5.3) 2. Do not expose touch panels to direct sunlight. 3. Avoid shock and vibration to the product.
Unpacking	<ol style="list-style-type: none"> 1. Open the box after checking the package is right side up 2. Do not grip and pull FPC when removing product. (in order to avoid disconnection.)
	<ol style="list-style-type: none"> 1. Use gloves and masks when handling touch panels. (in order to avoid leaving fingerprints or spots.) 2. Do not touch where the tails are heat-sealed to avoid disconnection. 3. Hold touch panels around outside of viewing area. 4. Clean off touch panel with soft cloth dampened with alcohol (IPA) when surface on the panel is dirty 5. Do not use organic solvents except alcohol (IPA). 6. Do not stack touch panels onto other touch panels. (The edge of the touch panel may cause scratches on the surface of the other touch panels.) 7. Do not put heavy objects on the panel. 8. Handle with care as the panels have sharp edges.
Assembly	<ol style="list-style-type: none"> 1. Please design a housing which minimizes stress onto touch panels. 2. Please pay attention not create any stress to the heat-sealed tails. (Heavy stress may cause disconnection) 3. Please pay attention not to harm touch panels with your tools which may be used for assembling.
Housing Design (Case Design)	<ol style="list-style-type: none"> 1. Keep enough clearance (over 0.3mm) between the touch panel and flat-panel display to protect a display device and display surface fig 1. 
	<ol style="list-style-type: none"> 2. Avoid the bezel design as below. Because it can press the 'Active Area' of the touch panel 
	<ol style="list-style-type: none"> 3. We recommend the use of a buffer material between the touch panel and the bezel. and buffer material should be limited only on the busbar area. If it is out of busbar area, touchpanel may occur a short 
Prohibitions & Operation	<ol style="list-style-type: none"> 1. Do not attach bezel to inside of panels viewing area. 2. Prevent excessive force on the touch panel. 3. Do not use a sharp instrument when operating. This may cause scratches to the touch panel surface 4. We recommend calibration after long time use.

RoHS Compliant

REV.NO.	REVISED	DATE	DRAWN	CHECKED	APPROVED
0	NEW DRAW	02.03.28	WJ.KIM		
1	Added REAR DAT	07.04.25	H.Y. IM	K.B.KIM	Y.J.OH

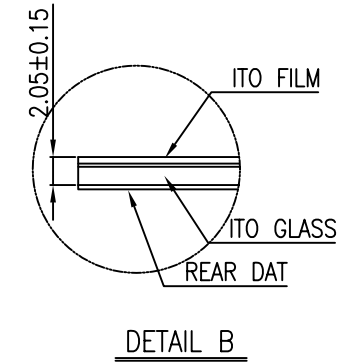
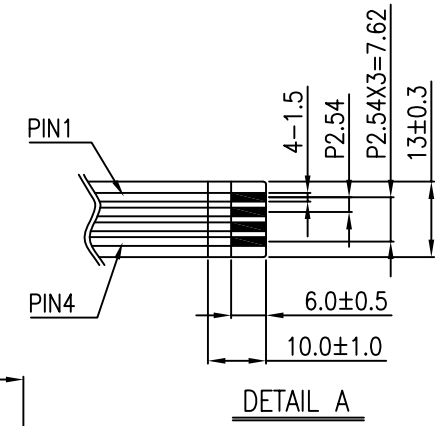
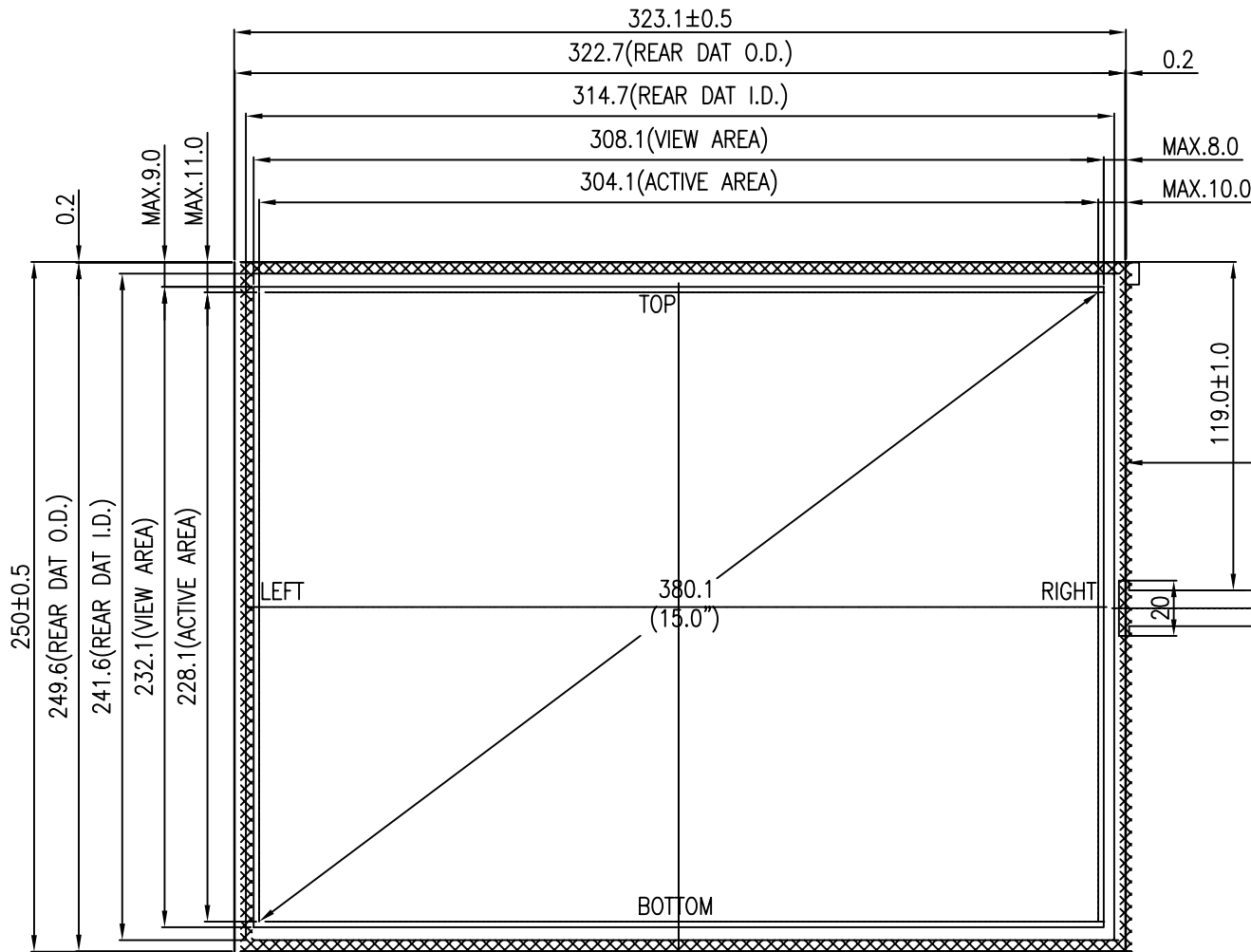

NOTE

- 1) TYPE : NON GLARE TYPE
- 2) GLASS THICKNESS : 1.8t
- 3) CONNECTOR : FPC
- 4) GENERAL TOLERANCE : ±0.5
- 5) Stylus use voids all warranties

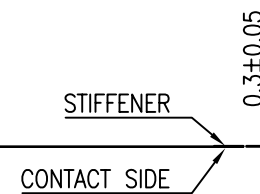
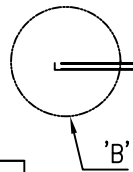

TERMINAL	
NO	SYMBOL
1	LEFT
2	TOP
3	RIGHT
4	BOTTOM

Approved _____

Signature _____

Printed Name _____

Company _____

Date _____

NOTE: The HantouchUSA Incoming Inspection Standard is part of this drawing. This quality and performance document can be viewed at: www.hantouchUSA.com, under Incoming Inspection Standards.

APPROVE	UNIT	mm	PROJECTION	DRAWING NO.	REV.
CHECK	SCALE	NONE		HT150A-NENBS52-R	
DESIGN	 Han touch USA Touch Screen Specialists			DESCRIPTION	SHEET
DRAW				15.0" TOUCH PANEL	1/1

Terms and Conditions of Sale

1. ACCEPTANCE

THE SALES TERMS AND CONDITIONS OF SALE CONTAINED HEREIN APPLY TO ALL QUOTATIONS MADE AND PURCHASE ORDERS ACCEPTED BY HantouchUSA FOR THE PURCHASE AND SALE OF ELECTRONIC COMPONENTS PRODUCTS. SOME OF THE SALES TERMS AND CONDITIONS SET OUT HERE MAY DIFFER FROM THOSE IN CUSTOMER'S PURCHASE ORDER AND SOME MAY BE NEW. **THIS ACCEPTANCE IS CONDITIONAL ON CUSTOMER'S ASSENT TO THE SALES TERMS SET OUT HERE IN LIEU OF THOSE IN CUSTOMER'S PURCHASE ORDER.** HantouchUSA'S FAILURE TO OBJECT TO PROVISIONS CONTAINED IN ANY COMMUNICATION FROM CUSTOMER SHALL NOT BE SEEMED A WAIVER OF THE PROVISIONS OF THIS ACCEPTANCE. YOUR AGREEMENT WITH OUR TERMS AND CONDITIONS SHALL BE CONCLUSIVELY EVIDENCED BY YOUR ACCEPTANCE OF ANY SHIPMENT. ANY CHANGES IN THE SALES TERMS CONTAINED HEREIN MUST SPECIFICALLY BE AGREED TO IN WRITING BY AN AUTHORIZED OFFICIAL OF HantouchUSA BEFORE BECOMING BINDING ON EITHER HantouchUSA OR CUSTOMER. All Orders must be approved and accepted by HantouchUSA at its headquarters office in Lynnwood Washington.

2. SPECIFICATIONS

Unless different specifications are established and agreed to in writing, the specifications for the Products are the written specifications issued by HantouchUSA for the part number assigned by HantouchUSA to the Products. Customer's part numbers are used for reference only. HantouchUSA may, without affecting the obligations of Customer, make insignificant changes to the specifications of the Products from time to time.

3. PRICES

If Customer does not purchase the entire quantity upon which these prices were based, Customer will pay the higher price specified by HantouchUSA for the quantity actually purchased. Prices do not include taxes and any tax HantouchUSA may be required to collect or pay upon the sale, use or delivery of the Products will be paid by Customer upon invoice.

4. PAYMENT

Unless otherwise set forth on the face hereof payment Sales Terms are net 30 days from date of invoice with interest on all unpaid amounts at the rate of 1.5% per month or the highest lawful rate, whichever is less. HantouchUSA reserves a purchase money security interest in the Products delivered until all of HantouchUSA's claims have been paid. HantouchUSA may change these credit Sales Terms if Customer's financial condition changes. Each shipment shall be considered a separate and independent transaction.

5. DELIVERY

Delivery will be f.o.b. HantouchUSA's location and will occur when the Products are ready for pickup by the carrier. In the absence of specific instructions, HantouchUSA will select a carrier. HantouchUSA does not assume any liability for the shipment. Customer will be responsible for all transportation and insurance charges, including those associated with warranty repairs. Delivery dates set forth on the face hereof are estimates only. HantouchUSA will use its best efforts to deliver in accordance with these dates but will not be responsible for failure to deliver as estimated.

6. INSPECTION

Within 30 days after delivery Customer will inspect the Products and give written notice of rejection to HantouchUSA detailing the manner in which any Products do not conform to the specifications. Upon receiving authorization and shipping instructions from HantouchUSA, Customer may return rejected Products. If Customer retains the Products after their delivery without giving HantouchUSA such notice within the designated period, Customer will be deemed to have irrevocably accepted the Products. Customer's inspection and acceptance tests shall not exceed the inspection and test procedures customary in the industry for the Products and shall be at Customer's expense. HantouchUSA may charge to Customer any costs resulting from the testing, handling, and disposition of any Products returned by Customer which are not found by HantouchUSA to be non-conforming.

7. WARRANTY

HantouchUSA warrants to Customer that the Products will be free from defects in material and workmanship under normal use and service for a period of one year from the date of manufacture. Customer's exclusive remedy for breach of this warranty is that HantouchUSA will either (i) repair or replace, at its option, any Product which fails during the warranty period because of such defect (if Customer promptly reported the failure to HantouchUSA in writing) or, (ii) if HantouchUSA is unable to repair or replace, HantouchUSA will refund the purchase price of the Product upon its return to HantouchUSA. This warranty does not apply to any Product which has been subjected to misuse, abnormal service or handling, or which has been altered or modified in design or construction, or which has been serviced or repaired by anyone other than HantouchUSA. The warranties set forth herein are in lieu of, and exclusive of, all other warranties, express or implied. ALL EXPRESS AND IMPLIED WARRANTIES OF MERCHANTABILITY, FITNESS FOR USE AND FITNESS FOR A PARTICULAR PURPOSE ARE SPECIFICALLY EXCLUDED.

8. CANCELLATION AND RESCHEDULING

ALL ORDERS ARE NON-CANCELABLE AND NON-RETURNABLE (NCNR). CUSTOMER MUST ACCEPT DELIVERY OF ALL ITEMS PLACED ON ORDER. All quantities must be released and shipments scheduled no more than 12 months from the date hereof. HantouchUSA may cancel this order or any portion in the event of Customer's default or a material adverse change in Customer's financial condition without affecting HantouchUSA's right and remedies. Except as otherwise provided herein orders accepted by HantouchUSA are firm and non-cancelable.

9. CONTINGENCIES

HantouchUSA shall not be responsible for any failure to perform due to unforeseen circumstances or to causes beyond HantouchUSA's reasonable control. Examples of such causes are acts of God, war, riot, embargoes, acts of civil or military authorities, fire, floods, accidents, strikes or shortages of transportation facilities, fuel, energy, labor or materials. HantouchUSA may defer delivery for a period equal to the delay caused by such contingency in the event of shortages for any reason whatsoever. HantouchUSA may allocate production among its customers.

10. LIMITATION OF LIABILITY

Liability of HantouchUSA to Customer, if any, under this contract for breach of contract or warranty, negligence or otherwise shall in no event exceed the total contract price specified herein less the purchase price of any items delivered and accepted hereunder. In no event shall HantouchUSA be liable to Customer or others for special, incidental or consequential damages for breach of any of the provisions of this contract, including without limitation, provisions regarding warranties, guaranties, indemnities, and patent infringement, or based upon any claims, demands, settlements, or lawsuits arising from or in connection with, the Products sold hereunder, such damages including, but not limited to, costs of removal and reinstallation of items, loss of good will, loss of profits, or loss of use. Customer assumes all liability for any and all damages arising from or in connection with, the use or misuse of the Products by Customer, its employees, or others.

11. HIGH-RISK APPLICATIONS

The Products have not been designed, manufactured, tested or qualified for use in any high-risk application (a "High-Risk Application"), including, but not limited to, the following: all military, life support or life sustaining, "medical device" as defined by applicable law, nuclear, vehicle control (including airplane, automotive, train and other vehicle) or any other application in which failure of the Product, or the product into which it is incorporated, could foreseeably result in personal injury, death, or significant property damage.

12. GENERAL

This is the complete and exclusive statement of the agreement between the parties and supersedes all prior agreements and communications about the subject matter. Neither this agreement nor individual transactions under it may be assigned by Customer without the prior written consent of HantouchUSA. Regardless of any disclosure made by Customer to HantouchUSA of an ultimate destination of the Products, Customer will not export, directly or indirectly, any Product without first obtaining all required licenses from appropriate government agencies.

To contact us, please call us at (425) 774-8151
send email to sales@hantouchUSA.com
Visit us on the web at www.hantouchUSA.com